

\* Caution

**TAITO<sup>®</sup>**

© TAITO CORP. 1995

- When working, make sure to turn OFF the power.
- Use the specified connector (56-pin edge connector having 3.96 mm pitch) for the edge connector of the ROM PC board.
- After turning on the power, adjust the power supplied to the mother PC board that its level becomes the rated voltage at the mother PC board connector section.
- After the modification, when "PUSH TEST SWITCH" appears on the screen, press TEST SWITCH on the mother P.C. Board without turning off the power.

[Connection of mother PC board and ROM PC board]

- Connect the ROM PC board on the mother PC board while referring the figure below.



## **INSTRUCTION MANUAL**

- \* Be careful about direction of the ROM PC board.

[Specifications for the control panel]

- Two sets of four dimensional joystick lever.
- Two sets of one button switches.

TAITO CORPORATION®

G2500807A



### \* Cautions

- Prior to executing the alternation work, make sure to turn OFF the power.
- Use a JAMMA standard connector (56 pin edge connector having 3.96 mm pitch) for the edge connector of the mother PC board.
- After turning on the power, adjust the power supplied to the mother PC board that its level becomes the rated voltage at the mother PC board connector section.
- After the modification ,when "PUSH TEST SWITCH" appears on the screen,press TEST SWITCH on the mother P.C.Board without turning off the power.

### [Connection of mother PC board and ROM PC board]

- Connect the ROM PC board on the mother PC board while referring the figure below.

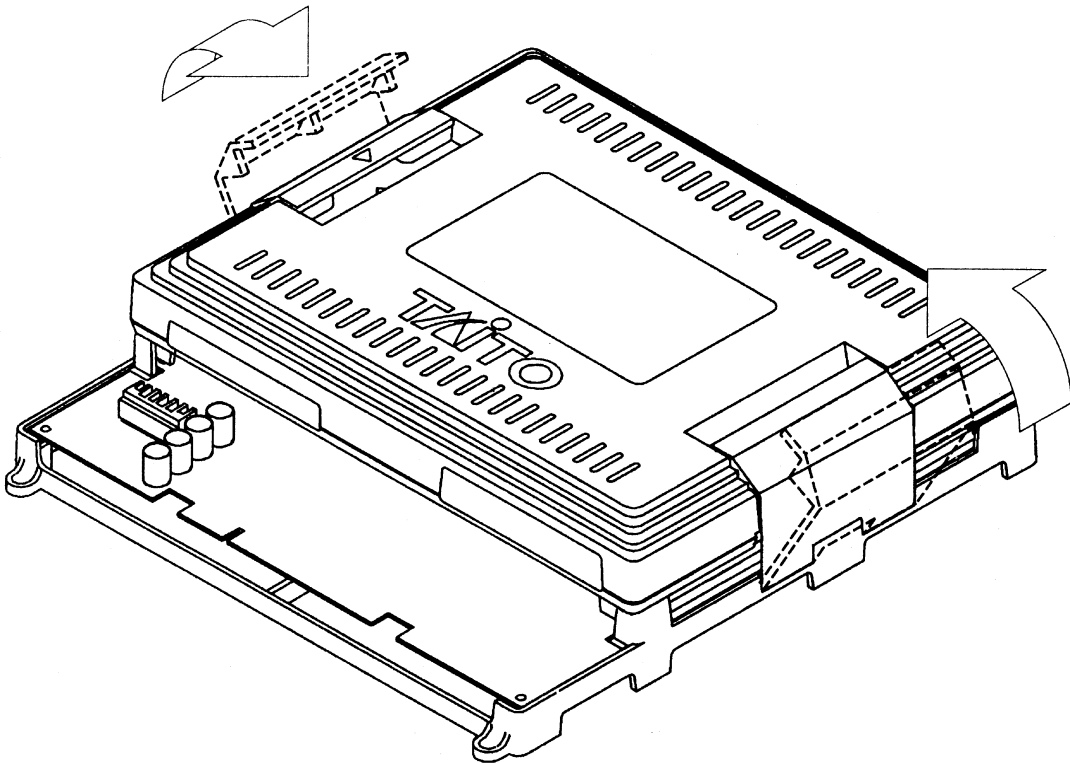

\* Be careful about direction of the ROM PC board.

### [Specifications for the control panel]

- Two sets of four dimensional joystick lever.
- Two sets of one button switches.

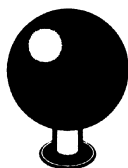

**[Mother PC board]**

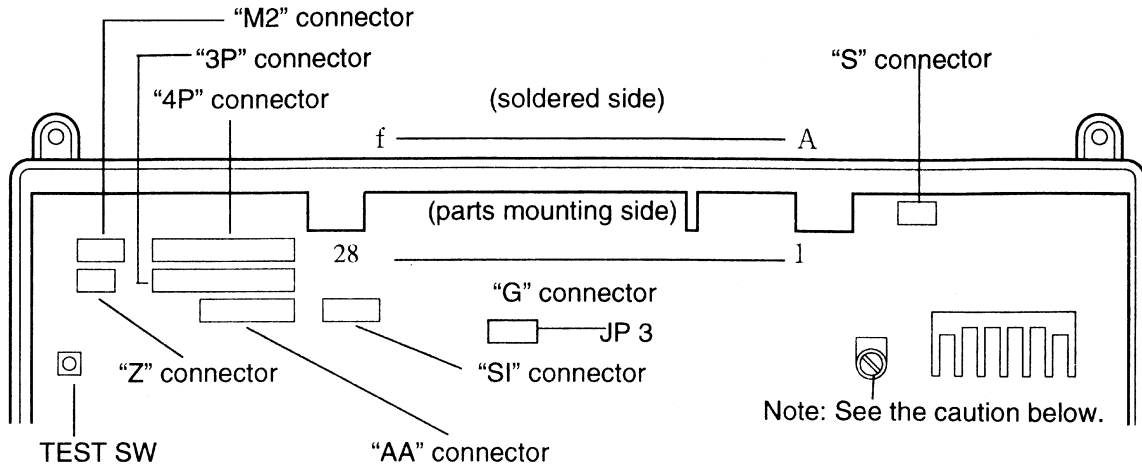

\* Set the JP3 to the "JOYSTICK" side.

- This PC board has no dip switches. For selecting play fee and game contents, set at the test mode.

**\*Caution:**

There is a dial on the PC board which is not for volume loudness adjustment. This dial is correctly adjusted at delivery. Never touch it.

**[Connector terminal list]**

G connector		JAMMA	
GND	1	A	GND
GND	2	B	GND
+5V	3	C	+5V
+5V	4	D	+5V
	5	E	
+12V	6	F	+12V
POST	7	H	POST
METER1	8	J	METER2
LOCKOUT1	9	K	LOCKOUT2
SPEAKER(+)	10	L	SPEAKER(-)
	11	M	
VIDEO R	12	N	VIDEO G
VIDEO B	13	P	SYNC
VIDEO GND	14	R	SERVICE
TEST	15	S	TILT
COIN 1	16	T	COIN 2
1P SELECT	17	U	2P SELECT
1P UP	18	V	2P UP
1P DOWN	19	W	2P DOWN
1P LEFT	20	X	2P LEFT
1P RIGHT	21	Y	2P RIGHT
1P FIRE BUTTON	22	Z	2P FIRE BUTTON
NO USE	23	a	NO USE
NO USE	24	b	NO USE
	25	c	
	26	d	
GND	27	e	GND
GND	28	f	GND

By connecting two speakers to the S connector as shown below, you can get realistic stereo sound.

"S" connector  
[In the case of applying a stereo system]

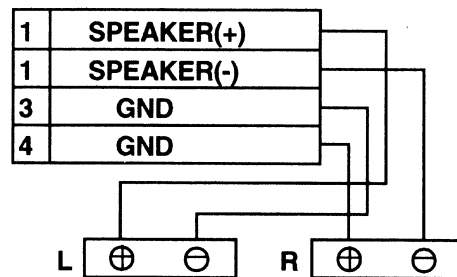

"S" connector  
[In the case of applying a monaural system]

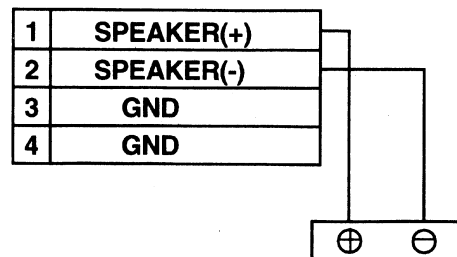

## [Description of test mode]

### [Test mode]

- Press the test switch on the PC mother board (or connect a line of the test switch in the G connector No. 15 with the GND), the game mode halts and the monitor changes to "Test mode."
- When you enter the test mode while having credits, the machine clears the credits.
- Move the cursor vertically by shifting the 1P side lever up and down, and press the "FIRE" or "SELECT" button. The machine initiates the test of the selected item.

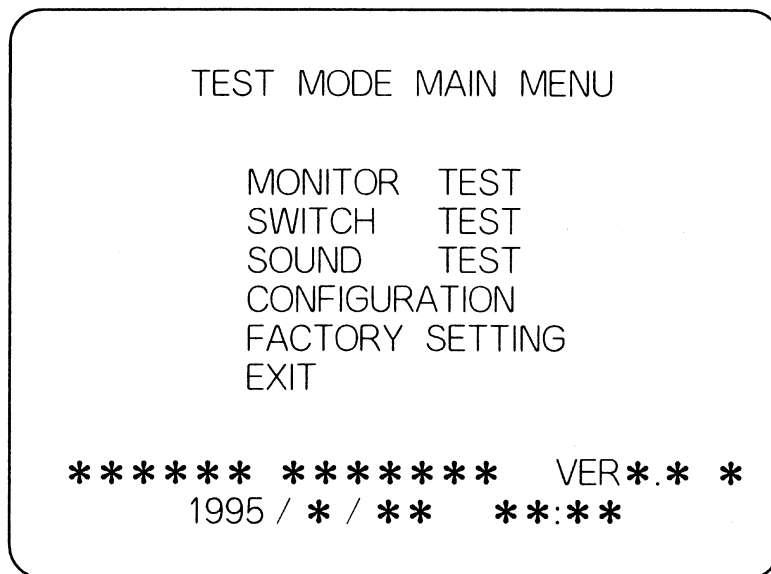

(Test mode main menu)

**[Monitor test]**

**Cross hatch**

- Check distortion of image.

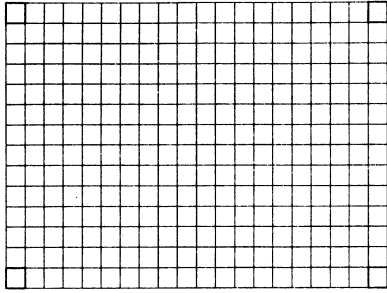

- Select the monitor test and the cross hatch screen will appear on the monitor.

**Color bar**

- Check hue of image.

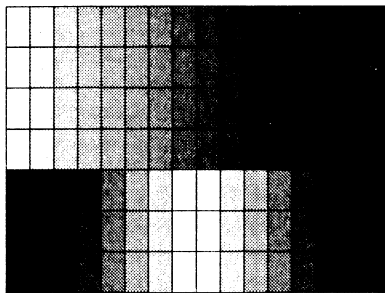

- Each press of the 1P side "FIRE " or "SELECT" button changes the display between the cross hatch screen and the color bar screen.

- Press TEST SWITCH on the P.C.Board ( or press 1P side "FIRE" and "SELECT" button ) , the monitor will return to the main menu.

**[Switch test]**

- This function checks the input of each switch.

SWITCH TEST

SERVICE	: OFF	TILT	: OFF
COIN A	: OFF	COIN B	: OFF
START	: OFF	START	: OFF
FIRE1	: OFF	FIRE1	: OFF
FIRE2	: OFF	FIRE2	: OFF
FIRE3	: OFF	FIRE3	: OFF
UP	: OFF	UP	: OFF
DOWN	: OFF	DOWN	: OFF
LEFT	: OFF	LEFT	: OFF
RIGHT	: OFF	RIGHT	: OFF

PUSH TEST SWITCH TO MENU

- Turn ON a switch and when the corresponding display on the screen changes from "OFF" to "ON," the switch is normal.
- Press TEST SWITCH on the P.C.Board ( or press 1P side "FIRE" and "SELECT" button), the monitor will return to the main menu.

**[Sound test]**

- This function adjusts the sound level during play of the game.
- Select a required item by shifting the 1P side lever up and down, and change the level by shifting the same lever left and right.
- Press the 1P side "FIRE" or "SELECT" button at the "SOUND NO." item, attractive sound a emit for your checking.
- After selecting with the lever on the 1P side , and when the 1P side "SELECT" or "FIRE" button is pushed, the sound stops.
- "MAIN" , "SE" VOLUME: The former adjust the B.G.M. during playing, and the later adjusts the effect sound volume. The sound volume increases by turning the 1P side lever to the right, and it decreases by turning the 1P side lever to the left.

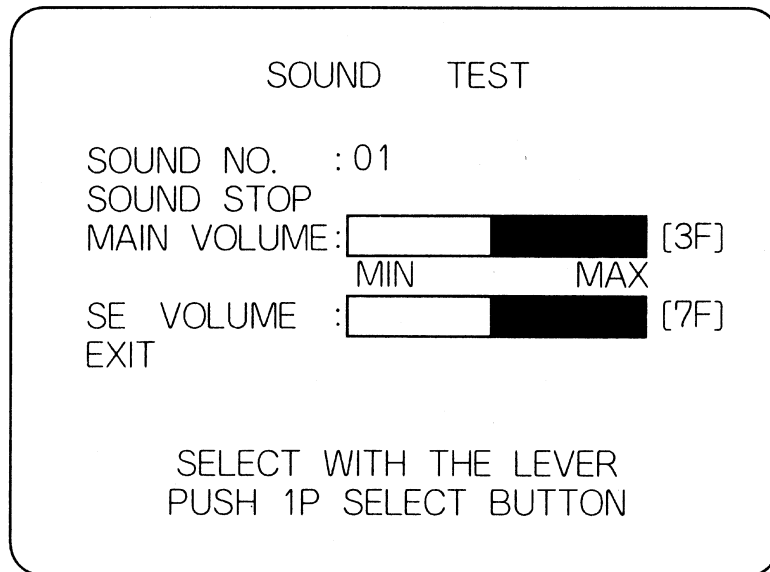

- Select "EXIT" and the machine asks whether or not to write the set data as below. "YES" and "NO" can be changed by turning the 1P side lever left and right. If you want to store the data just set, select "YES." If you do not want to change the settings, select "NO." Then press the 1P side "FIRE" or "SELECT" button.

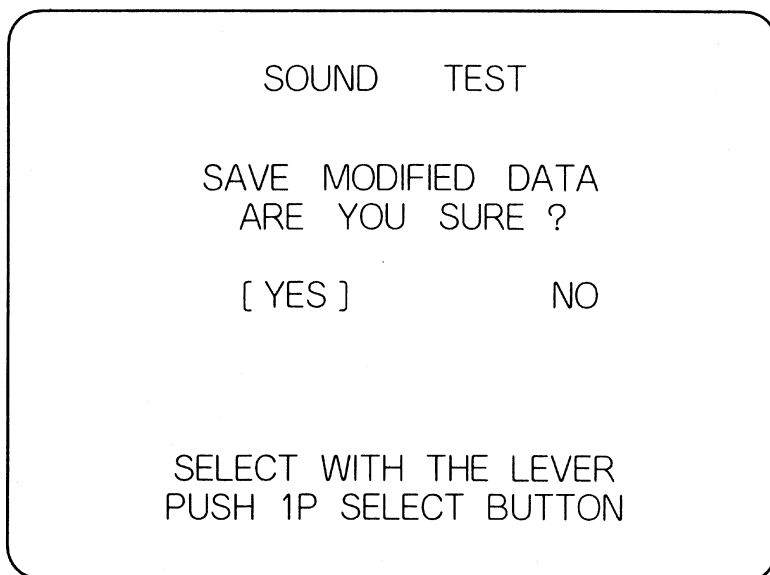

**[CONFIGURATION]**

- This function sets the play fee and game contents.
- Select a required item by shifting the 1P side lever up and down, and change the contents by shifting the same lever left and right.
- \* For the contents of the configuration, see the next page.

CONFIGURATION

GAME STYLE : D (1P+2P )  
MONITOR : NORMAL  
ATTRACT SOUND: ON  
DIFFICULTY : NORMAL  
CONTINUE MODE : ON  
INTRUDE PLAY : ON  
VS CREDIT : 1  
VS ROUND : 3  
COIN-A : 1 COIN 1 CREDIT  
COIN-B : 1 COIN 2 CREDIT  
EXIT

SELECT WITH THE LEVER  
PUSH 1P SELECT BUTTON

- Select "EXIT" and the machine asks whether or not to write the set data as below. "YES" and "NO" can be changed by turning the 1P side lever left and right. If you want to store the data just set, select "YES." If you do not want to change the settings, select "NO." Then press the 1P side "FIRE" or "SELECT" button.

CONFIGURATION

SAVE MODIFIED DATA  
ARE YOU SURE ?

[ YES ]                      NO

SELECT WITH THE LEVER  
PUSH 1P SELECT BUTTON



[Configuration list]

\* Factory setting

[COMMON SETTING]

GAME STYLE	* D (2P)
	E (1P ONLY)
MONITOR	* NORMAL
	INVERT
ATTRACT SOUND	* ON
	OFF
DIFFICULTY	EASY
	* NORMAL
	HARD
	VERY HARD
CONTINUE MODE	* ON
	OFF
VS. ROUND	1 #1
	* 3 #2
	5 #3

[FOR NORTH AMERICA]

VS.CREDIT	1	1COIN 1CREDIT
	* 2	1COIN 2CREDIT
PLAY	* 1COIN	* 1CREDIT
	2COINS	2CREDITS
	3COINS	3CREDITS
PRICE	4COINS	4CREDITS
		5CREDITS
		6CREDITS

[EXCEPT NORTH AMERICA]

VS.CREDIT	* 1	1COIN 1CREDIT
	2	1COIN 2CREDIT
COIN-A	* 1COIN	* 1CREDIT
	2COINS	2CREDITS
	3COINS	3CREDITS
	4COINS	4CREDITS
		5CREDITS
		6CREDITS
COIN-B	* 1COIN	1CREDIT
	2COINS	* 2CREDITS
	3COINS	3CREDITS
	4COINS	4CREDITS
		5CREDITS
		6CREDITS

#1: The game ends when either 1P or 2P games one victory.

#2: The game ends when either 1P or 2P games two victory.

#3: The game ends when either 1P or 2P games three victory.

**[Factory setting]**

- This function sets all the settings to the factory setting conditions.

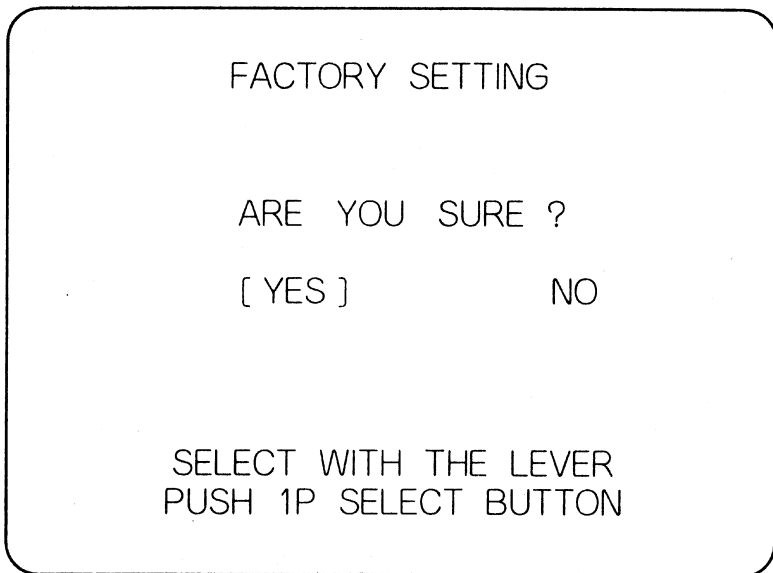

- If you want to set all the settings to the factory set conditions, select "YES." If you do not want to change the current settings, select "NO". Then press the 1P side "FIRE" or "SELECT" button.
- When you have replaced the other ROM PC board, make sure to execute the "factory setting".

**[EXIT]**

- To end the test mode, select "EXIT" on the main menu and press the 1P side "FIRE" or "SELECT" button.
- Select "YES" or "NO" by turning the 1P side lever left or right. To finish the test mode, select "YES", and to continue the test mode, select "NO", and then decide it by pushing the 1P side "SELECT" or "FIRE" button.  
( After selecting "YES", when the test mode is finished, the screen returns to attract mode.)

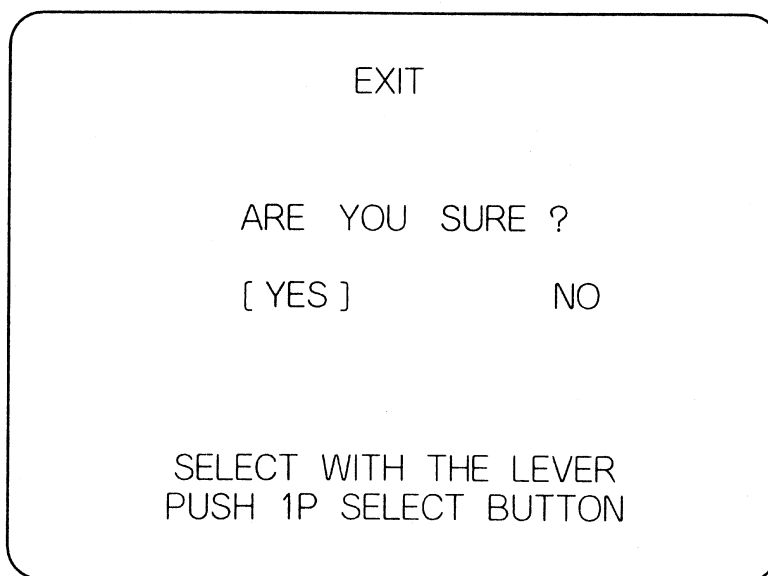

# [HOW TO PLAY ]

[TEXT]

To end the last mode, select "EXIT" on the main menu and press the 1P side "FIRE" or "SELECT" button.  
Select "YES" or "NO" by turning the 1P side lever left or right. To finish the last mode, select "YES", and to continue the last mode, select "NO", and then decide if by pushing the 1P side "SELECT" or "FIRE" button.  
(After selecting "YES", when the last mode is finished, the screen returns to attract mode.)

G3500547A

**TAITO**

# PUZZLE BUBBLE 2

## HOW TO PLAY

DIRECTION OF BUBBLE LAUNCHER



LAUNCH



WHEN ANY BUBBLE GOES OVER THE LINE, THE GAME IS OVER!



BUBBLES CAN BE ELIMINATED BY PUTTING 3 OR MORE SAME COLORED BUBBLES TOGETHER.

### SPECIAL BUBBLES

-  **STAR BUBBLE**  
ALL SAME COLORED BUBBLES HIT FIRST BY THIS STAR BUBBLE WILL BE ELIMINATED.
-  **METAL BUBBLE**  
METAL BUBBLE CAN ELIMINATE ALL BUBBLES.
-  **OBSTRUCTIVE BUBBLE**  
THESE BUBBLES CANNOT BE ELIMINATED!

\*THE MAXIMUM CREDITS FOR THIS GAME IS 9.



