

HV

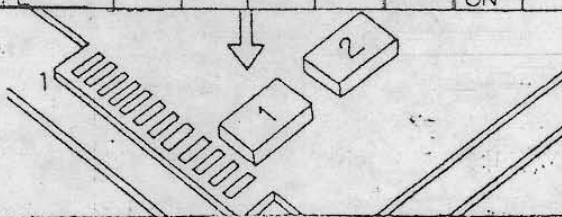

SWITCH 1

NUMBER OF PLAYER	3	1	2	3	4	5	6	7	8
	OFF	OFF							
	ON	OFF							NOT USE
	OFF	ON							
	ON	ON							
BONUS PLAYER	20000		OFF						
1 (1P)	50000		ON						
2 (2P)	60000			OFF					
	90000			ON					
DEMO SOUND WITH					OFF				
WITHOUT					ON				
TABLE TYPE						OFF			
UP RIGHT TYPE						ON			



SWITCH 2

		1	2	3	4	5	6	7	8
1 COIN 1 CREDIT	OFF	OFF							
1 COIN 2 CREDIT	ON	OFF							NOT USE
2 COIN 1 CREDIT	OFF	ON							
FREE PLAY	ON	ON							
2 1 COIN 3 CREDIT			OFF	OFF					
1 COIN 5 CREDIT			ON	OFF					
2 COIN 3 CREDIT			OFF	ON					
3 COIN 1 CREDIT			ON	ON					
EASY					OFF				
HARD					ON				
SCREEN INVERSION									

コネクター端子表

SOLD SIDE		PART SIDE	
ハンダ面		部品室	
A	P1-UP	P1-DOWN	1
B	P1-LEFT	P1-RIGHT	2
C	P1-PUSH1	P1-PUSH2	3
D	P2-UP	P2-DOWN	4
E	P2-LEFT	P2-RIGHT	5
F	P2-PUSH1	P2-PUSH2	6
H	COIN1	COIN2	7
J	GND	GND	8
K	GND	GND	9
L	+5	+5	10
M	+12		11
N		+12	12
P	+5	+5	13
R	GND	GND	14
S	GND	GND	15
T	1PLAY	2PLAY	16
U	TEST	SERVICE	17
V	COUNTER1	COUNTER2	18
W	SP(+)	SP(-)	19
X		R	20
Y	G	B	21
Z	GND	SYNC	22

## ■テストモード

(テスト画面)

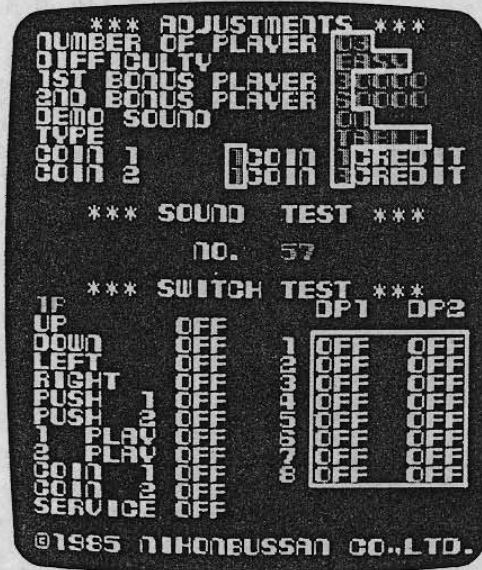

### ADJUSTMENTS

- ディップスイッチの設定状態を表示します。
- ディップスイッチをON/OFFにする事によって  中の表示が変わります。

### SOUND TEST

- サウンドの種類を表示します。
- コントロールレバーを上を倒すごとに、次のサウンドに進み、下を倒すと前のサウンドに戻ります。

### SWITCH TEST

- スイッチ関係、すべてのON/OFFを表示します。
- 通常、画面及び操作部のスイッチテストは1 P側になっていますが、2 P側の操作部のスイッチを1つでもONにすると画面は反転し、2 P側のスイッチテストが出来ます。

## ■コネクター端子表



ハンダ面		部品面	
A	P1-UP	P1-DOWN	1
B	P1-LEFT	P1-RIGHT	2
C	P1-PUSH1	P1-PUSH2	3
D	P2-UP	P2-DOWN	4
E	P2-LEFT	P2-RIGHT	5
F	P2-PUSH1	P2-PUSH2	6
H	COIN1	COIN 2	7
J	GND	GND	8
K	GND	GND	9
L	+5	+5	10
M	+12		11
N		+12	12
P	+5	+5	13
R	GND	GND	14
S	GND	GND	15
T	1PLAY	2PLAY	16
U	TEST	SERVICE	17
V	COUNTER1	COUNTER2	18
W	SP(+)	SP(-)	19
X		R	20
Y	G	B	21
Z	GND	SYNC	22

※マグマックス及びテラクレスタとコネクターが同仕様です。

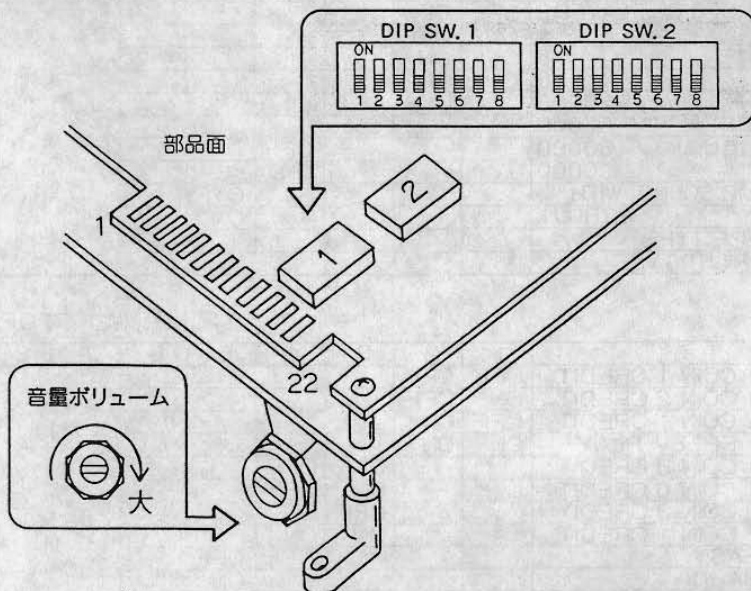
DIP SW. を切り換える時は、一度電源を切って下さい。







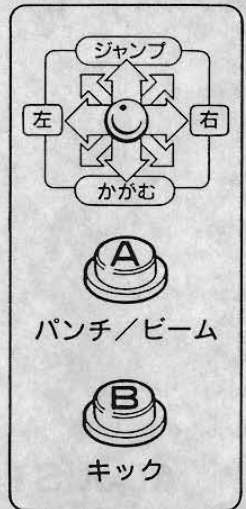

## HOW TO PLAY

- 8方向レバーで、PLAYER  をコントロールする事が出来ます。
- 画面中央下部の  パワーがなくなると一人アウト。

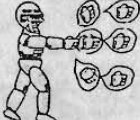

## 変身/必殺攻撃

-  パワークリスタルをクリアしてパワーが満タンになると、PLAYER  は  ギャリバンに変身し、パワーが半分以下になると、変身は解除されます。
- PLAYER がギャリバンに変身している時にパワークリスタル  (青)をクリアすると、必殺武器レーザーブレード剣  を8秒間使用する事が出来る。パワークリスタル  (赤)をクリアすると必殺武器コスミッククラッシュ  を8秒間使用する事が出来る。

## DIP SWITCH 設定表

### SWITCH 1

工場出荷時はすべてOFF

	1	2	3	4	5	6	7	8
NUMBER OF PLAYER3	OFF	OFF						
4	ON	OFF						
5	OFF	ON						
6	ON	ON						
BONUS PLAYER20000			OFF					未
(1回目) 50000			ON					使
(2回目以降) 60000				OFF				
90000				ON				用
DEMO SOUND WITH					OFF			
WITHOUT					ON			
TABLE TYPE						OFF		
UP RIGHT TYPE						ON		

### SWITCH 2

工場出荷時はすべてOFF

	1	2	3	4	5	6	7	8
1 COIN 1 CREDIT	OFF	OFF						
1 COIN 2 CREDIT	ON	OFF						
2 COIN 1 CREDIT	OFF	ON						
FREE PLAY	ON	ON						
2 COIN 3 CREDIT			OFF	OFF				
1 COIN 6 CREDIT			ON	OFF				
2 COIN 3 CREDIT			OFF	ON				
3 COIN 1 CREDIT			ON	ON				
EASY					OFF			
HARD					ON			
SCREEN INVERSION						*		

※ご使用になるモニターにより、画面が反転している場合があります。その際、SCREEN INVERSION SW.を反対方向にセットして下さい。画面方向が変わります。(プレイヤー方向は変わりません。)



WIRING CONNECTOR

DIP SWITCH ADJUSTMENTS

SOLDER SIDE

PARTS SIDE

A	P1-UP	P1-DOWN	1
B	P1-LEFT	P1-RIGHT	2
C	P1-PUSH 1	P1-PUSH 2	3
D	P2-UP	P2-DOWN	4
E	P2-LEFT	P2-RIGHT	5
F	P2-PUSH 1	P2-PUSH 2	6
H	COIN 1	COIN 2	7
J	GND	GND	8
K	GND	GND	9
L	+5	+5	10
M	+12		11
N		+12	12
P	+5	+5	13
R	GND	GND	14
S	GND	GND	15
T	1 PLAY	2 PLAY	16
U	TEST	SERVICE	17
V	COUNTER 1	COUNTER 2	18
W	SP (+)	SP (-)	19
X		R	20
Y	G	B	21
Z	GND	SYNC	22

SWITCH 1

	1	2	3	4	5	6
Number of Player	3	OFF	OFF			
	4	ON	OFF			
	5	OFF	ON			
	6	ON	ON			
Bonus Player 20000 (1 st) 50000			OFF			
			ON			
(after 2nd) 60000 90000				OFF		
				ON		
Demo Sound WITH WITHOUT					OFF	
					ON	
Type TABLE UP RIGHT						OFF
						ON

SWITCH 2

	1	2	3	4	5	6
Coin 1	1 Coin 1 Credit	OFF	OFF			
	1 " 2 "	ON	OFF			
	2 " 1 "	OFF	ON			
	Free Play	ON	ON			
Coin 2	1 Coin 3 Credit			OFF	OFF	
	1 " 6 "			ON	OFF	
	2 " 3 "			OFF	ON	
	3 " 1 "			ON	ON	
Difficulty	EASY					OFF
	HARD					ON
Screen Inversion						*

